

Transformers

ACADEMY

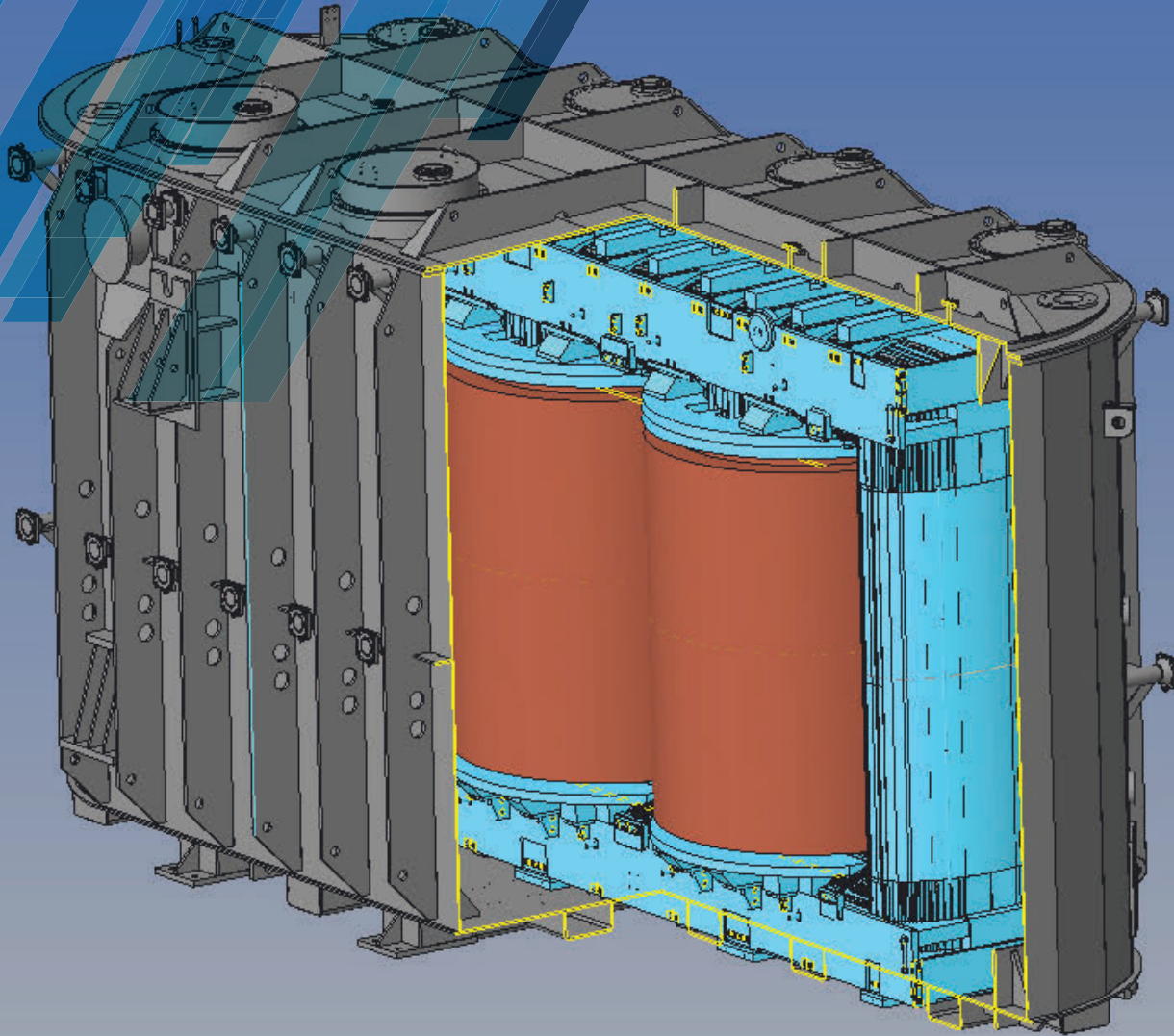

DESIGN OF POWER TRANSFORMERS COURSE

COURSE AUTHOR: ALEKSANDAR LOJPUR



Aleksandar Lojpur
Master of Electrical Engineering

ALEKSANDAR LOJPUR

Aleksandar Lojpur is a Master of Electrical Engineering, having obtained the degree at the Faculty of Electrical Engineering and Computing at the University of Zagreb, Croatia.

In the period from 2014 to 2021 he performed the duty of Head of Electrical design at the Končar Power Transformers Ltd., a joint venture of Siemens Energy AG and Končar, while from 2019 to 2020 he was a lecturer at the Postgraduate Specialist Study in Transformers - Transformer Design at the University of Zagreb, Faculty of Electrical Engineering and Computing.

His most notable projects include 200 MVA auto-transformer with phase shift regulation for Croatia, 560 MVA, 550 kV single phase autotransformer for USA; 1,000 MVA, 420 kV autotransformer for Norway; 200 MVA and 350 MVA network transformers for solar power plants for Spain, 400 MVA, 245 kV split winding network transformer, SC-tested for Netherlands and more.

WHAT MAKES THIS COURSE UNIQUE?

Although transformer design has been described in many excellent papers and books, each power transformers manufacturer has developed internal tools for adapting physical models in order to calculate their transformer as accurately as possible.

This series of lectures will attempt to closely describe to a wider audience the design challenges in meeting all the necessary requirements and their importance to transformer reliability.

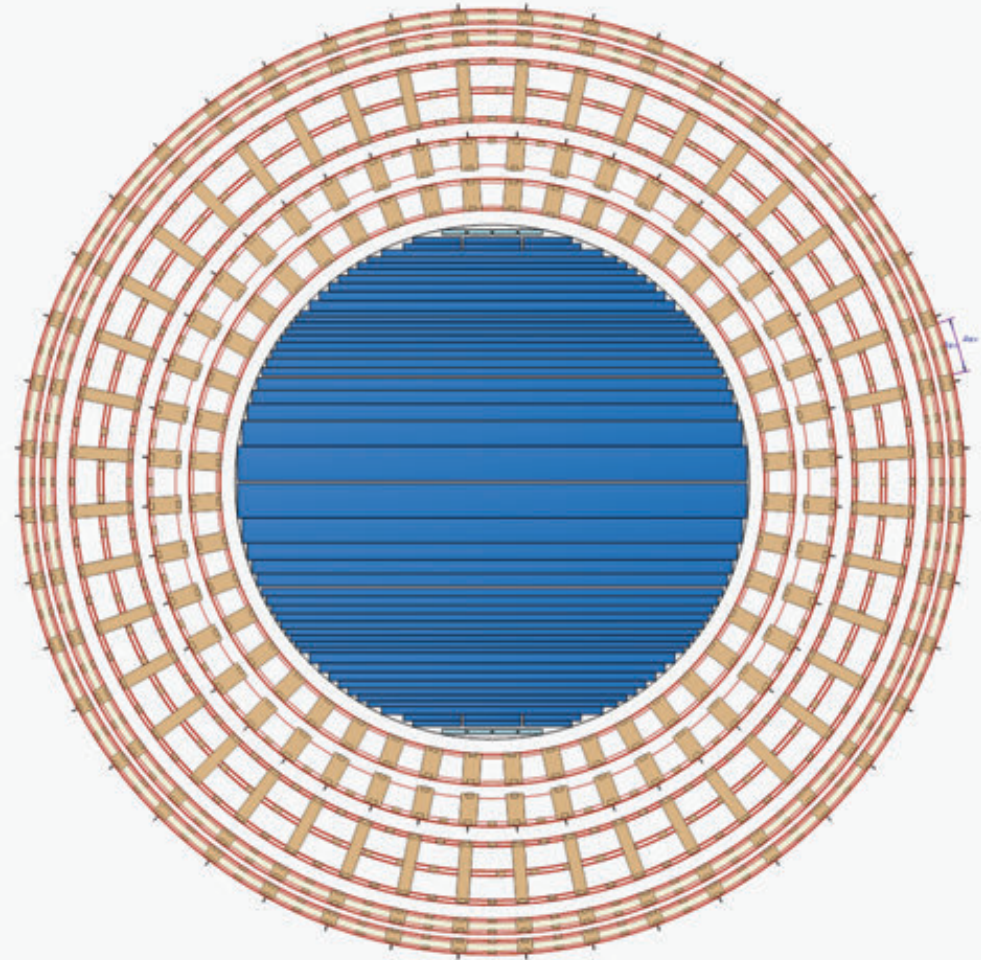

TARGET AUDIENCE

The course is intended for:

1. Utility engineers supporting maintenance or procurement.
2. Manufacturers of transformers (design engineers; procurement, service, test, PM engineers).
3. Manufactures of transformer components.
4. Students who want to understand transformer design practice and application.



OVERVIEW

INTRODUCTORY / BASIC LEVEL

LESSON 1

Design of Power Transformers – Design process

- Design in a life cycle of a power transformer
- Design requirements
- Design process steps

LESSON 2

Design of Power Transformers – Components and calculations

- Metal parts
- Active part
- Insulation liquids
- Accessories
- Calculations

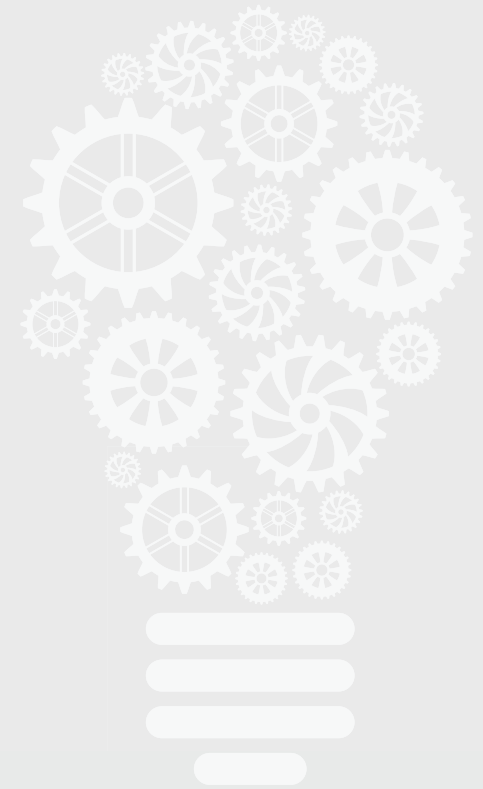
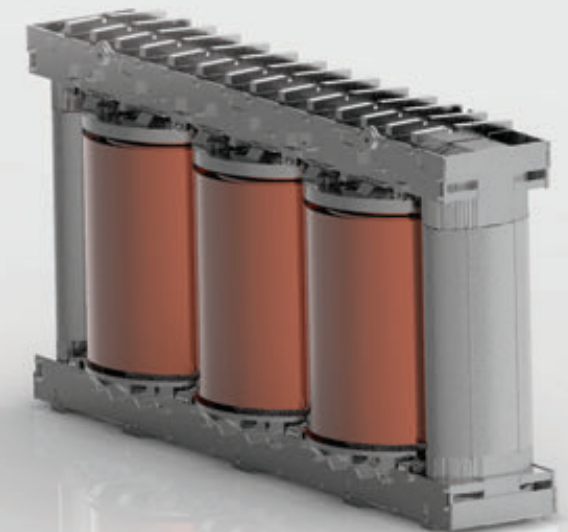
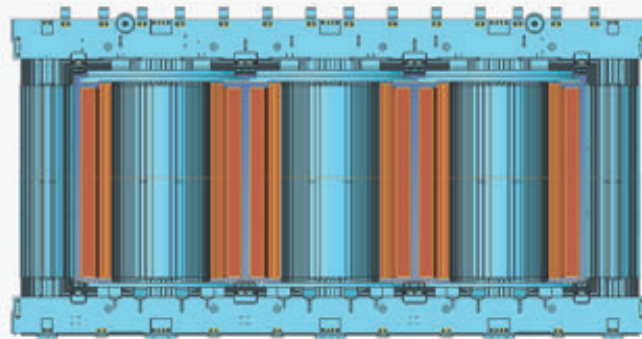

LESSON 3

Design of power transformers - Fundamentals of dielectric design

- Electrical insulation materials:
 - Definition and types
 - Properties
- Electric field and voltage distribution
- Methods to calculate electric field and voltage distribution
- Breakdown and partial discharges
- Dielectric tests and their purpose
- Highest voltage for equipment and rated insulation level

LESSON 4

Design of power transformers - Fundamentals of thermal design

- Heat transfer
- Cooling methods
- Temperature rises
- Thermal image
- Indirect vs direct hot-spot measurements in the windings
- Transformer components exposed to heating

INTERMEDIATE LEVEL

LESSON 1

Design of power transformers - Core and no-load losses

- Core function
- Core material
- Core types
- Core geometry
- Core losses
- Core temperature rise
- Clamping frame and bandaging system
- Core earthing

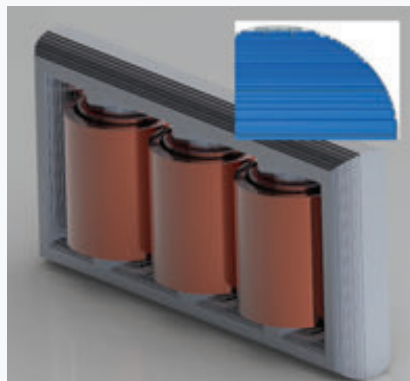

LESSON 2

Design of power transformers - Windings

- Function
- Conductors (types, materials, dimensions & tolerances)
- Components and parameters
- Winding types
- Windings by the function
- Winding manufacturing process
- Winding dimensions
- Conductor insulation

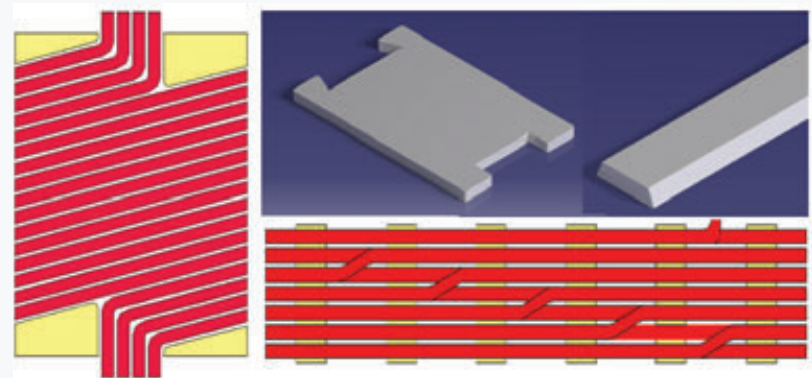

LESSON 3

Design of power transformers – Load losses and measures to reduce additional losses

- Stray field
- Ohmic losses
- Skin losses
- Circulating currents
- Losses in different metal parts
- Principles of stray field control, losses and local hot spots reductions

LESSON 4

Design of power transformers – Short circuit withstand

- Short circuit types
- Short circuit currents
- Short circuit forces
- Short circuit stresses
- Maximum permissible stresses
- Measures to improve short circuit withstand

LESSON 5

Design of Power Transformers – Insulation design

- Insulation materials
- Voltage conversion factors
- Weidmann curves
- Voltage scheme
- Insulation outside the windings
- Insulation inside the windings

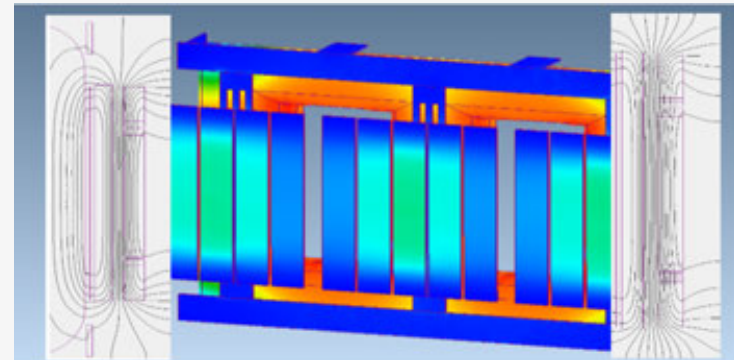
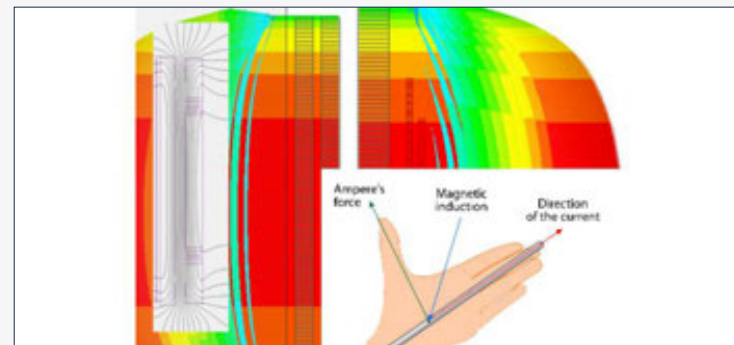

ILLUSTRATION CREDIT: INFOLOGIC DESIGN <https://www.infologicdesign.co.uk/>



LESSON 6

Design of Power Transformers – Temperature rise

- Transformer cooling system types
- Calculation principles
- Thermal image for different cooling methods
- Temperature rise limits

LESSON 7

Design of Power Transformers – Noise

- No-load noise
- Load noise
- Cooling equipment noise
- Principles of noise reduction

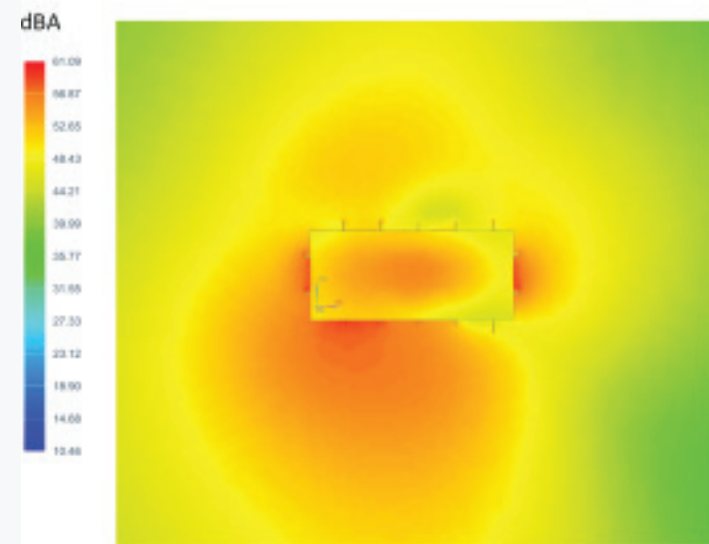
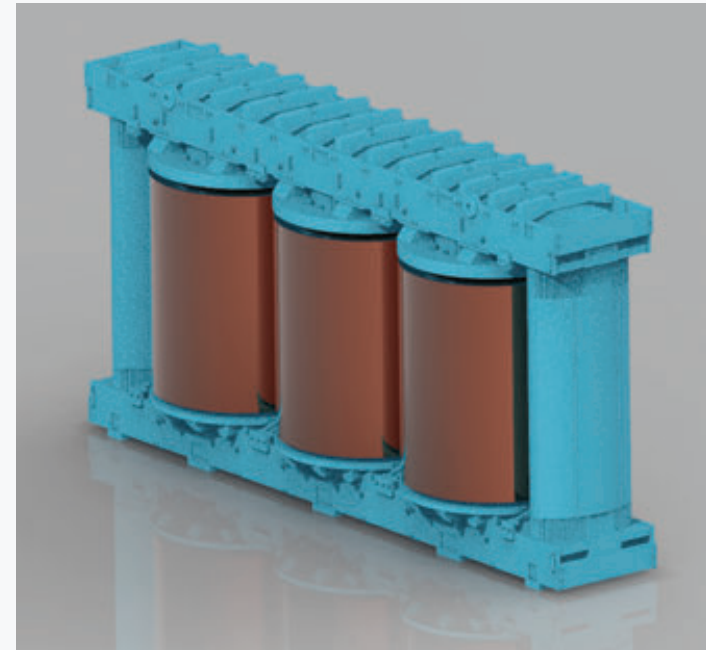

MASTER'S LEVEL

LESSON 1

Design of Power Transformers – Regulation concepts

- Constant flux voltage variation
- Variable flux voltage variation
- Indirect regulation
- Direct regulation
- Off-circuit / on-load regulation
- Linear, coarse-fine, reverting regulation, taps inside the winding

LESSON 2

Design of Power Transformers – Ability to withstand short circuit

- Evaluation of the transformer by comparison with a reference transformer that has successfully passed the short-circuit test
- Evaluation of the transformer by check against the manufacturer's design rules for short-circuit strength

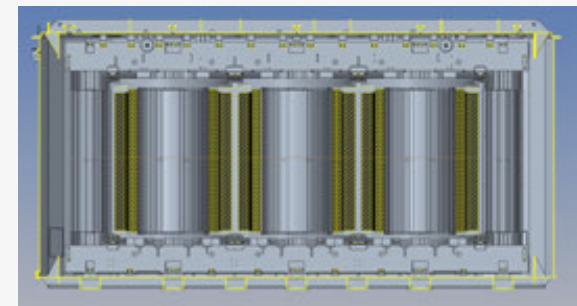
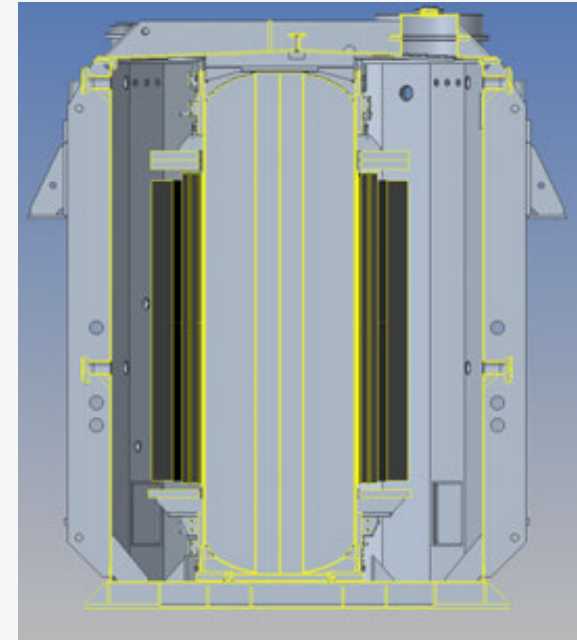

LESSON 3

Design of Power Transformers - Efficiency, voltage drop & PEI

- Efficiency calculation
- Voltage drop calculation
- PEI calculation

LESSON 4

Design of Power Transformers - Insulation in a nutshell

- Application of Weidman curves maximum and cumulative methods
- Creepage
- Hybrid and high temperature insulation systems

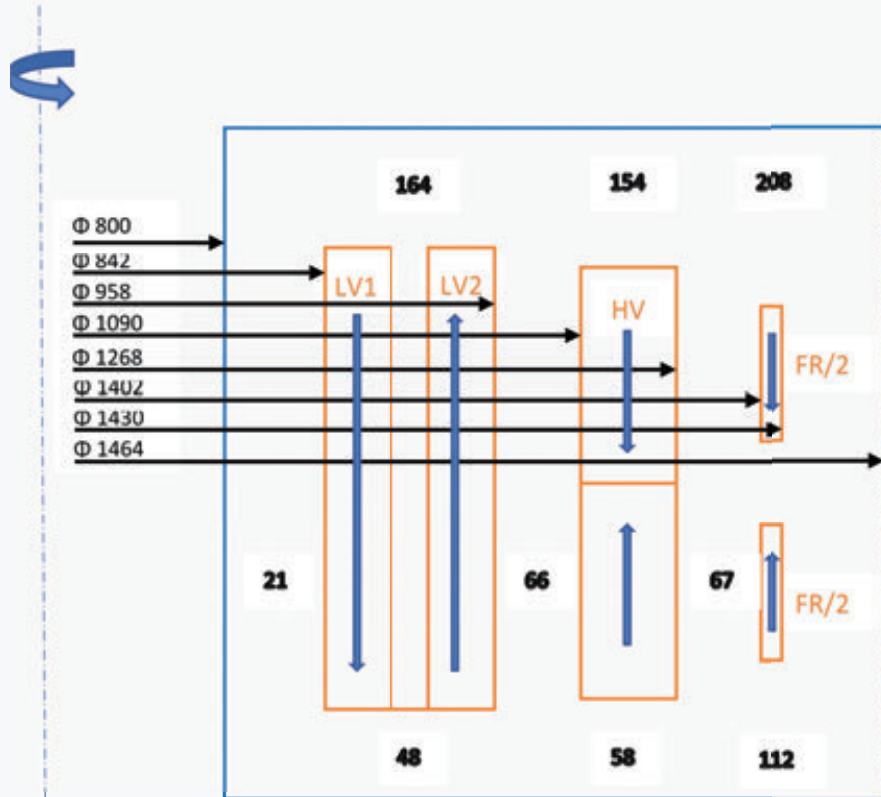

Transformers

ACADEMY



info@merit-media.com



transformers-academy.com